

Force Sensor KD40s 50N

Item number: 834

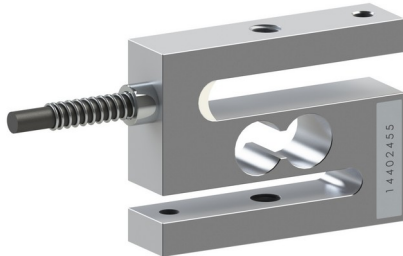

The force sensor KD40S is very well suited for testing tasks in quality assurance as well as in materials testing due to its compact construction. Inward and outward force transmission are arranged centrally. The force sensors KD40S up to 100N are constructed as multi-range sensors. The accuracy of 0.1% is already reached at an rated output of 0.5 mV/V. This means that the zero-point stability is 4 times higher than in a sensor with the nominal output of 2 mV/V. The force sensor KD40S can be used up to an output signal of 2 mV/V or four times the specified nominal force. The force sensor KD40S (up to 100 N) should be installed in such way that the outgoing cables are assigned to the immobile side of the measuring construction. Thus forces from the connecting cable do not have an influence on measurement results. From 500N upwards the force sensors KD40s have a nominal rated output of 1.0mV/V. They can safely be overloaded up to 1.5x their nominal force. The cable output can be found in the middle of the two force transmission beams. For force transfer there exists one thread M5 (up to 100N) and M6 (from 500N) in the top and bottom side of the force sensor. Additionally there is a thread M6 (from 500N) that can be used as anti-twist protection. The force sensor from a nominal force of 1000N has a height of 34 mm.

Technical Drawing

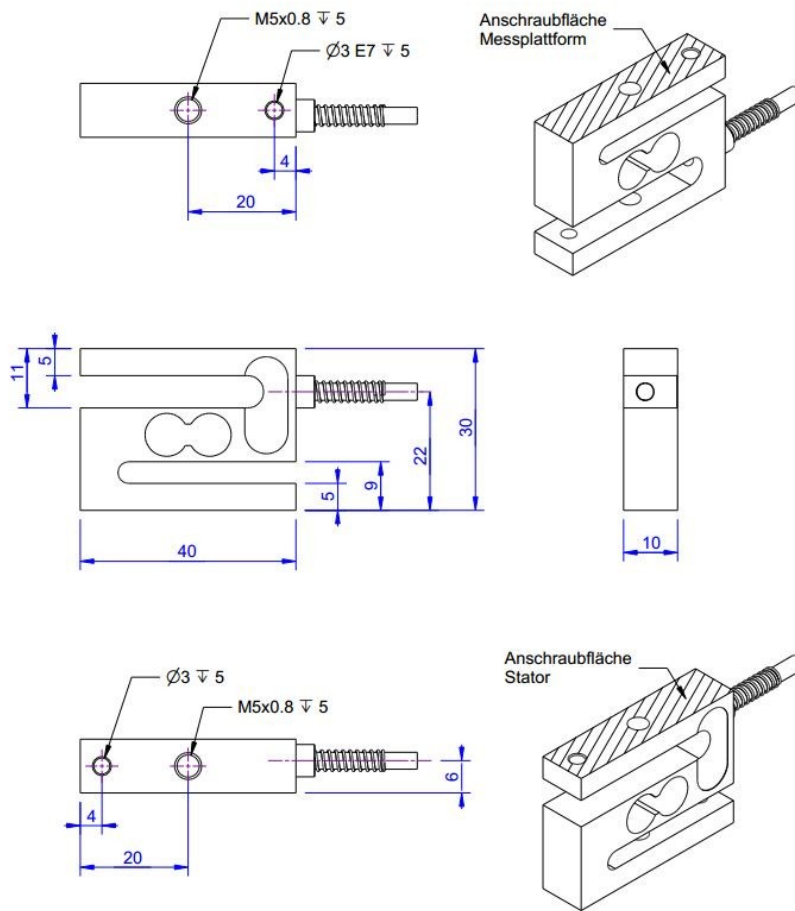

Technical Data

Basic Data		Unit
Type	Kraftsensor	
Force direction	Tension/Compression	
Rated force Fx	50	N
Force introduction	Internal thread	
Dimension 1	M5x0,8	
Sensor Fastening	Internal thread	
Dimension 2	M5x0,8	
Operating force	400	%FS
Rated displacement	0.2	mm
Lateral force limit	100	%FS
Material	aluminum-alloy	
Natural frequency fx	1800	Hz
Dimensions	30... 34mm x 40mm x 10mm	
Height	30	mm
Length or Diameter	40	mm
Torque limit	3	Nm
Bending moment limit	3	Nm
Variants	2N... 5kN	

Electrical Data		Unit
Input resistance	390	Ohm
Tolerance input resistance	40	Ohm
Output resistance	350	Ohm
Tolerance output resistance	5	Ohm
Insulation resistance	2	GOhm
Rated range of excitation voltage from	2.5	V
Rated range of excitation voltage to	5	V
Operating range of excitation voltage from	1	V
Operating range of excitation voltage to	10	V
Zero signal	0.05	mV/V
Rated output	0.5	mV/V / FS

Accuracy Data		Unit
Accuracy class	0,1	
Relative linearity error	0.02	%FS
Relative zero signal hysteresis	0.02	%FS
Temperature effect on zero signal	0.02	%FS/K
Temperature effect on characteristic value	0.01	%RD/K
Relative creep	0.1	%FS

Environmental Data		Unit
Rated temperature range from	-10	°C
Rated temperature range to	70	°C
Operating temperature range from	-10	°C
Operating temperature range to	85	°C
Storage temperature range from	-10	°C
Storage temperature range to	85	°C
Environmental protection	IP65	

Abbreviation: RD: „Reading“; FS: „Full Scale“;
The exact sensitivity is indicated in the test report;

Pin Assignment

Channel	Symbol	Description	Wire color	PIN
	+Us	positive bridge supply	brown	
	-Us	negative bridge supply	white	
	+Ud	positive bridge output	green	
	-Ud	negative bridge output	yellow	

Screen - transparent. Compressive load : positive output signal